



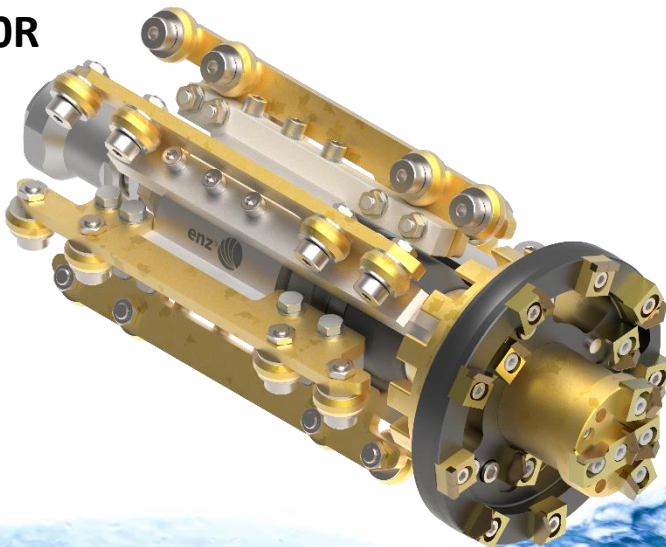
# IMC Recycling Impact Milling Cutter

14.200RP

14.200R

14.225R

14.250R



Operating manual

English

May 25 | Version 1.2



# Content

<b>Preface</b> .....	<b>4</b>
<b>Purpose of the document</b> .....	<b>4</b>
<b>1 Safety</b> .....	<b>5</b>
1.1 Consequences of noncompliance with safety instructions .....	5
1.2 Target group .....	5
1.3 User requirements .....	5
1.4 Explanation of general safety instructions .....	5
1.5 Types of notices in this operating manual.....	6
1.6 Intended use.....	6
1.7 Safety instructions for modifications .....	7
1.8 Protective equipment for working in manholes, pits, and sewers.....	7
1.9 General safety instructions .....	9
<b>2 Legal</b> .....	<b>11</b>
2.1 Copyright .....	11
2.2 Disclaimer .....	11
2.3 Warranty conditions.....	11
<b>3 IMC recycling impact milling cutter</b> .....	<b>12</b>
3.1 Introduction.....	12
3.2 Basic function .....	12
3.3 Thrust .....	13
3.4 Application range .....	13
3.4.1 Pipe material .....	13
<b>4 Installation</b> .....	<b>14</b>
4.1 Preparing the recycling impact milling cutter .....	14
4.2 Installing the tools .....	14
4.3 Preparation.....	15
4.3.1 General preparation.....	15
4.4 Setting up the work area .....	15
<b>5 Operation</b> .....	<b>17</b>
5.1 Operating the tool against the direction of flow .....	17
5.2 Operating the tool in the direction of flow .....	18
5.3 Cleaning pipes with minor damage .....	20
5.4 After use .....	20
5.5 Troubleshooting .....	21
5.5.1 The impact cutter head is not rotating .....	21
5.5.2 The impact cutter head stops often.....	21
5.5.3 Insufficient impact force .....	21
5.5.4 Insufficient impact force despite new cam plates .....	21
5.5.5 Recycling impact milling cutter travels upward in the pipe .....	21
<b>6 Maintenance</b> .....	<b>22</b>

6.1	Intermittent maintenance during milling .....	22
6.2	Checking nozzle inserts .....	22
6.2.1	Replacing the nozzle inserts .....	23
6.2.2	Adjusting the thrust for different pipe inclinations .....	23
6.3	Greasing rotating parts .....	24
6.3.1	Cutter hub .....	24
6.3.2	Swivel joint .....	24
6.4	Replacing milling teeth .....	25
6.5	Removing the center cap .....	26
6.6	Installing the center cap .....	26
6.7	Removing excess grease from the cutter hub .....	27
6.8	Replacing the cam plates .....	27
6.9	Replacing the aluminum bronze washer .....	30
6.10	Disposal and environmental protection .....	31
<b>7</b>	<b>Technical specifications .....</b>	<b>32</b>
7.1	Nomenclature .....	32
7.2	Screw torques .....	33
7.3	Retrofitting the recycling impact milling cutter to other diameters .....	34
7.3.1	Replacing the cutter head .....	34
7.3.2	Adjusting the skids .....	35
<b>8</b>	<b>Milling tooth .....</b>	<b>37</b>
8.1	Milling tooth overview .....	37
8.2	Tooth position overview .....	37
8.3	Milling teeth on the center cap .....	38
8.4	Milling teeth on the inside ring .....	38
8.5	Milling teeth on the outside ring .....	39
8.5.1	Tooth positions on the outside ring .....	40
8.6	Milling in plastic pipes .....	40
8.6.1	PE pipes .....	40
8.6.2	PVC pipes .....	40
8.7	Setup for limescale deposits .....	41
8.8	Limescale deposits in plastic pipes .....	41
8.9	Wood and plastic deposits .....	42
8.10	Setup for concrete deposits .....	43
<b>9</b>	<b>Special applications .....</b>	<b>44</b>
9.1	Turning impact on and off .....	44
9.2	Milling with the diamond crown drill bit .....	45
9.3	Installing the pull rod .....	46
<b>10</b>	<b>Spare parts/accessories .....</b>	<b>47</b>
<b>11</b>	<b>Accessories .....</b>	<b>49</b>
11.1	Milling teeth .....	49
11.2	Retrofit kit .....	49

11.3 Center caps and cutter heads.....50  
 11.4 Diamond crown drill bit.....51  
 11.5 Miscellaneous.....51  
**12 Index.....53**  
 12.1 Figures .....53  
 12.2 Drawings.....54  
 12.3 Tables .....54

Version	Revision	Date	Initials
1.0	Created	October 24	bbi
1.1	Change of QR-Code	March 25	lgo
1.2	Greasing interval adjusted	May 25	rri

## Preface

### Dear customer

Thank you for the confidence and trust you've placed in us by purchasing one of our products.

We always appreciate suggestions and ideas for improvement. Your feedback will help us improve the design of our product and the associated documentation.

If you have any questions or suggestions, please contact our Customer Service Department:

**enz® technik ag**

Phone +41 41 676 77 66

info@enz.com



**Feedbackformular**

[www.enz.com/de/header/feedback](http://www.enz.com/de/header/feedback)

Person responsables for documentation:

Bryan Bieri (Tech. Support/QM Manager)

We reserve the right to modify and update our products without prior notice as a result of technological advances. Misprints reserved.

## Purpose of the document

This operating manual contains information about using our product correctly, effectively, safely, and for its intended purpose. Risks, reasonably foreseeable misuse, and residual risks are detailed in this operating manual.



### Important

Read carefully before use.

Keep for later reference.

---

Read this operating manual thoroughly before using the cleaning tool. Ensure that all employees who work with the equipment understand this operating manual.

The operating manual must be available to operating personnel at all times. Store it in an easily accessible location.

If the operating manual is misplaced or destroyed, request a new copy from your dealer or the manufacturer.

# 1 Safety

## 1.1 Consequences of noncompliance with safety instructions

Disregarding these safety instructions may lead to accidents involving serious injuries, material damage, and environmental damage.

The manufacturer is not liable for damage resulting from noncompliance with these safety instructions.

## 1.2 Target group

This operating manual is intended for all persons who will be involved in the installation, start-up, and operation of the pipe cleaning tool.

## 1.3 User requirements

All persons involved with installation, start-up, and operation of the tool must

- Be familiar with the field of sewer maintenance work and have the appropriate technical knowledge.
- Have the appropriate training to use the product.
- Have read and understood the operating manual, in particular the **Safety** section.

Personnel without the necessary knowledge must be trained accordingly. If necessary, the pipe cleaning tool manufacturer can provide this instruction and training.

Only the maintenance and service activities described in this manual may be performed by users who have met the requirements above. Other maintenance and service work may only be performed by the manufacturer's technicians.



Observe the information in the **Maintenance** section.

---

## 1.4 Explanation of general safety instructions

The general safety instructions in this section provide information about potential residual risks that are inherent to the product or may occur unexpectedly despite using the product as intended.

To prevent injuries, material damage, and environmental damage, all personnel working with this product must comply with these safety instructions. These personnel must read and understand the information in this section.

## 1.5 Types of notices in this operating manual



### DANGER

Hazards that will cause **death** or serious injury upon nonobservance.



### WARNING

Hazards that may cause serious injury and/or permanent disability upon nonobservance.



### CAUTION

Hazards that may cause injury and considerable material damage, financial loss, or environmental damage upon nonobservance.



Information on the technically correct and efficient use of the product.

## 1.6 Intended use

The product is designed for cleaning the insides of pipes (i.e., sewer cleaning). Observe the following points for proper use of the tool:

- ⚠ The cleaning tool may be used only in pipes or pipe-like sewers. The surface to be cleaned must be free of leaks and must be surrounded by material.
- ⚠ The tool may be used on the following types of pipes:
  - PE pipes
  - Steel pipes
  - Concrete pipes
- ⚠ Contact the manufacturer for use in pipes made of another material.
- ⚠ Only use the product with connections that are correct and sound.
- ⚠ Secure cleaning areas (manholes, pipe branches, etc.) sufficiently during operation, including during setup and cleaning.
- ⚠ **No one** may be inside the pipes or at either end of the pipes during operation.
- ⚠ Do **not** exceed the maximum pressure indicated on the nozzle.
- ⚠ Do **not** drain wastewater into creeks, rivers, etc.
- ⚠ Inspect the product for sound condition before every start-up.
- ⚠ Rectify defects before start-up.

- ⚠ Use the tool only as intended (only use a wrench of the correct size).
- ⚠ Secure the hose lines such that they cannot become damaged during operation.
- ⚠ Only use the accessories provided and approved by *enz® technik ag*.

## 1.7 Safety instructions for modifications

No unauthorized changes or modifications may be performed to the pipe cleaning tool. Only use parts authorized by the manufacturer. The manufacturer is not liable for damage resulting from unauthorized changes to the product.

## 1.8 Protective equipment for working in manholes, pits, and sewers

The employer must provide suitable personal protective equipment (PPE). The employer must ensure that employees wear PPE during work.

The protective equipment prescribed by Suva (Swiss National Accident Insurance Fund) is described below.

For more information on this, refer to the brochure:

**Safe entry and work in manholes, pits, and sewers**

**Order number: 44062.d**

Suva  
Schweizerische Unfallversicherungsanstalt  
Arbeitssicherheit  
Postfach, 6002 Lucerne, Switzerland  
For information:  
Phone +41 419 51 11  
For orders:  
[www.suva.ch/waswo](http://www.suva.ch/waswo)  
Phone +41 419 58 51

**Respirator**

Atmosphere-supplying respirator for working in hazardous atmospheres and for use during rescue operations.

**Respirator**

Self-contained self-rescuer (devices with a compressed air tank or regeneration device) for working in sewers and providing first aid.

**Rescue harness**

Rescue harness or protective clothing with a loop into the neck. During rescue, the rescue rope will be attached to the neck loop. Injured persons will be lifted out using a rescue lifting device with an automatic brake.

**Suitable work clothing**

Intact work clothing protects the skin from soiling and infection. Visually conspicuous work clothing makes the employee more visible to traffic.

**Appropriate footwear**

In particular, safety shoes should have good grip and be slip resistant and waterproof (e.g., rubber boots).

**Gloves**

Appropriate gloves prevent hand injuries and protect against contact with untreated water and substances that are harmful to health.

**Hardhat**

Hardhats protect the head from falling objects and from bumps by fixed components and objects.

**Hearing protection**

Earmuffs with built-in headphones and microphone can be worn if sound levels could cause hearing loss.

**Eye protection**

Protect your eyes from fragments, sprays, hazardous substances, etc.



### Lighting independent of the power grid

Carry a water-resistant flashlight or wear a headlamp.

## 1.9 General safety instructions

### Danger | High-pressure water jets



Defects in or unintended use of the product could create a hazard from pressurized water spray. Personnel may not be in the sewer during operation. Ensure that the product is in perfect condition before operation. Piercing water jets can cause serious injury and can sever limbs.

### Danger | Toxic gases



Sewers may contain toxic gases. Wear the required protective equipment such as gas masks, gas detectors, and rescue harnesses. Inhaling toxic gases or particulate-containing air could be **fatal** or lead to serious injuries if particulate enters the lungs.

### Warning | Falling objects



Objects can fall into open manholes and onto personnel below the opening. Never work directly under the manhole opening when equipment is being guided in. Secure the manhole entrance to prevent falling parts. Do not throw tools or objects down into the manhole. Do not enter manholes where there is a risk of collapse. Personnel could become trapped.

### Warning | Chemical burns



There may be unidentified, corrosive, or otherwise harmful substances in sewers. Wear appropriate protective clothing. Use the required protective equipment. Failure to do so could cause chemical burns to the skin and eyes or lead to infection by pathogens.

### Warning | Falls



The product is used near open manholes. Provide warning indications regarding open manholes. Pay attention to where you are walking.

### Warning | Hand injuries



Tampering with the equipment creates a risk of hand injury from hands or fingers getting caught or scraped. Wear gloves during work. Pay attention to where you hold the product. Heavy equipment requires a team lift. Consequences of tampering can include crush injuries, abrasions, or loss of limb.

**Caution | Sharp objects**

Tampering with the product creates a risk of hand injuries due to sharp edges. Wear gloves during work. Pay attention to where you hold the product. Consequences of tampering can include cutting injuries to your hands or other parts of your body.

**Caution | Trip hazards**

There will be lines and other objects on the ground in the area near where the product is being used. Pay attention to where you are walking. Keep the job site tidy. Tripping and falling could cause serious injuries.

## 2 Legal

### 2.1 Copyright

This manual shall not be duplicated, photocopied, reproduced, translated, or converted into an electronic or machine-readable format, in whole or in part, without the prior written permission of **enz® technik ag**.

©2025 enz® technik ag, 6074 Giswil, Switzerland.  
All rights reserved.

### 2.2 Disclaimer

The manufacturer is not liable for damage that:

- Is the result of unauthorized changes to the product.
- Is caused by noncompliance with the safety instructions.

### 2.3 Warranty conditions

In accordance with our sales and delivery conditions, we offer a warranty. The warranty is void if:

- The product is used under prohibited conditions.
- Replacement or accessory parts that are not original parts from **enz® technik ag** are used.
- Damage is caused by:
  - Improper use
  - Noncompliance with the operating manual
  - Unsuitable materials
  - Incorrect or improper routing of hoses or pipelines
  - Unauthorized changes or modifications to or conversions of the product

## 3 IMC recycling impact milling cutter

### 3.1 Introduction

enz® recycling impact milling cutters are designed for milling extremely hard deposits in pipes. A turbine drive makes the recycling impact milling cutters suitable for use with recycled and fresh water. Recycling impact milling cutters pulse at a rate of 600 – 3000 pulses per minute at an impact force of up to 12 tons. Carbide or diamond teeth are used based on the hardness of the deposits.

Recycling impact milling cutters have a modular construction. In the application range of  $\varnothing$  190 – 250 mm (7.5" – 9.9"), the corresponding head can be installed on the hub. Skids are replaced or adapted based on the diameter.

### 3.2 Basic function

The recycling impact milling cutter is guided through the pipe via the skids (1). The thrust nozzles (2) generate thrust and propel the recycling impact milling cutter forward through the pipe. The swivel joint (3) between the recycling impact milling cutter and the hose prevents the hose from twisting. In idle mode, the cutter head (4) ramps up to 5000 – 6000 RPM via the turbine (5) and drive nozzles (6). The speed during operation is 200 – 1000 RPM. The carbide teeth (7) mill deposits out at a rate of 600 – 3000 pulses per minute.

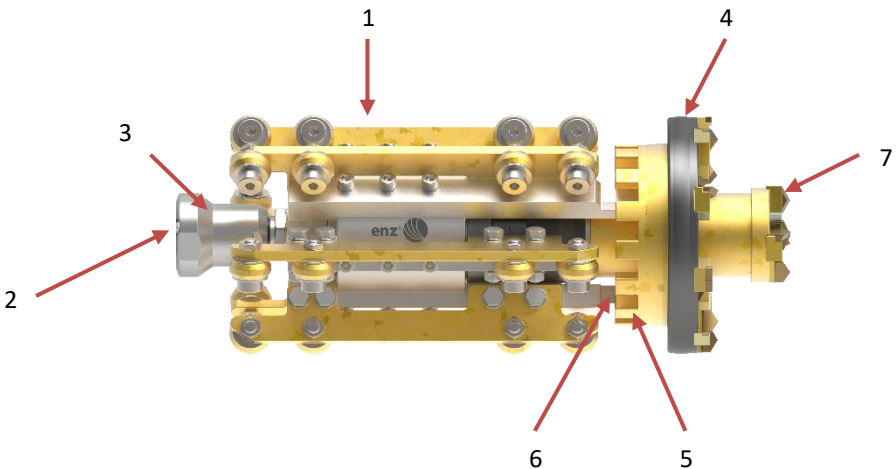


Figure 1: Basic function

### 3.3 Thrust

The three thrust nozzles (2), which are mounted on the swivel joint (3), can be replaced at any time based on the task to be completed. This provides control over the contact pressure and the tool's forward gliding motion. Prepare various nozzle inserts for the thrust before milling. The procedure for replacing the nozzle inserts is described in **Section 6.2** on **page 22**.

The impact milling cutter works faster and more efficiently when it is properly equipped.



#### CAUTION

Only change the thrust. Do not change the nozzle inserts for the cutter head's rotation. Failure to comply can lead to cutter or pipe damage.

### 3.4 Application range

- Limescale
- Concrete
- Injections
- Etc.

#### 3.4.1 Pipe material

We recommend using an impact milling cutter in cast iron, concrete, and plastic pipes. Contact the manufacturer for use in pipes made of another material.



#### CAUTION

Different milling teeth are installed in different positions based on the pipe material and deposits. See **Section 8** on **page 37**.

## 4 Installation

### 4.1 Preparing the recycling impact milling cutter

Prepare the recycling impact milling cutter for the specific task before using it. Check the following before working:

- Will the cutter fit in the pipe?  
Adapt the cutter head diameter and skid diameter to the pipe diameter. See **Section 7.3** on **page 34**.
- Are the correct milling teeth installed? Are they positioned properly? Were they tightened to the correct torque?  
See **Section 8** on **page 37**.
- Tighten all screws to their specified torques to ensure the torques are correct.  
See **Section 7.2** on **page 33** for the applicable torques.
- Are the cutter hub and swivel joint lubricated sufficiently? See **Section 6.3** on **page 24**.

### 4.2 Installing the tools

Tools are delivered operationally ready and are set up at the factory for milling with impact. After unpacking, check the delivery for completeness. Screw the recycling impact milling cutter onto the pressure hose. See **Section 7** on **page 32** for the different thread specifications of the recycling impact milling cutter.

Seen from behind, they normally rotate anti-clockwise.



Ensure that no soiling enters the tool when screwing it onto the pressure hose. Particulate could clog the inserts.

---

## 4.3 Preparation








### 4.3.1 General preparation








It is a good idea to clarify some points before use. Knowledge of the following points is helpful during preparation and when adjusting the recycling impact milling cutter:

- Routing of lines
- Inner pipe diameter and length of the sewer where work will be performed
- Pipe material, condition, and layout
- Type of material to be removed from the pipe and its proportion of the diameter in percent
- Planned flushing direction – we recommend that you work against the direction of flow
- Pitch of the sewer where work will be performed
- Sewer access options (a clearance of 2/3 the length of the tool is required)
- Disclaimer signed by the customer

## 4.4 Setting up the work area

Observe the points below when preparing the work area. These are essential for ensuring workplace safety.

-  Set up barriers and safety equipment (warning signs, safety barriers, etc.).
-  Block off and secure the work area such that there is no risk of falling or of danger from traffic.
-  Obtain information regarding the wastewater entering the manhole (chemicals, gas, vapors, etc.).
-  Measuring instruments such as explosive gas meters, oxygen meters, and gas detectors must be readily available.
-  Ensure that the appropriate nozzle sizes for cleaning the pipes are available. See “Technical specifications” on **page 32** for the application range of the cutter.
-  The layout of the lines (sewer maps) must be known before starting work to prevent the nozzle from emerging at a pipe end. Support personnel must monitor possible emerging points.
-  The customer must sign the disclaimer to protect against possible damage.

-  The surface of the work area must be clean and non-slip. Remove loose obstacles from the work area.
-  Ensure sufficient lighting at the work area.
-  The work area must provide sufficient freedom of movement and enable the operator to assume a stable posture.
-  The work area must enable water to drain or flow away.
-  Scaffolding must be rigid and stable. It must be secured against tipping, falling, and being pushed over.
-  Work platforms and scaffolding must comply with occupational safety requirements and may only be erected by trained specialists.
-  Before working, secure loose parts that are to be cleaned.

## 5 Operation

### 5.1 Operating the tool against the direction of flow

When possible, work against the direction of flow so the flow of water in the sewer is not interrupted.

1. Use a standard nozzle to flush all loose rocks out of the pipe before milling. Loose rocks can hinder the work process and damage the teeth of the recycling impact milling cutter.
2. Use a camera to survey the condition of the pipes and general parameters.
3. Ensure that the recycling impact milling cutter was properly set up and prepared. See **Section 4.1** on **page 14**.
4. Push the recycling impact milling cutter into the pipe to be cleaned to at least half the length of the cutter.
5. Start up the recycling impact milling cutter at about 80 bar and guide it in up to the deposit.
6. Slowly increase the pressure of the recycling impact milling cutter to 100 bar. This pressure is usually sufficient to mill and clean a pipe effectively.
7. Hold the high-pressure hose in your hand and feel the vibrations from the impact. When you no longer feel vibrations, pull the recycling impact milling cutter back slightly and then slowly guide it back up to the deposit.
8. After two minutes, stop milling, remove the recycling impact milling cutter, and check the teeth with a torque wrench per **Section 7.2** on **page 33**.
9. Use a camera to check the progress and milling results and to check for pipe damage.
10. Insert the recycling impact milling cutter back into the pipe and continue milling.
11. Check the progress after one hour. To do so, remove the cutter from the pipe and check the progress with a camera. Also check the teeth for wear. Use a torque wrench to tighten the screws of the milling teeth and cutter head per the instructions in **Section 7.2** on **page 33**. Perform this check hourly.
12. Grease the hub of the recycling impact milling cutter at least every four hours. See **Section 6.3** on **page 24**.
13. Use a torque wrench to check the tightness of the cage screws at least once daily. See **Section 7.2** on **page 33**.
14. Use a camera to check the milling progress regularly.

15. After milling, perform a thorough cleaning with a rotating nozzle or chain scraper.
16. Check the clean pipe with a camera. Look in particular for damage and for liquids escaping into the environment. Close all manholes after cleaning.



Thrust nozzles usually have to be adjusted based on whether milling will occur in the direction of flow or against the direction of flow. See **Section 6.2 on page 22**.



Excess grease accumulates behind the center cap during operation. This can greatly limit the effectiveness of impact and inhibit rotation. Remove excess grease daily. See **Section 6.7 on page 27**.

## 5.2 Operating the tool in the direction of flow

The nozzles must be adapted to use the recycling impact milling cutter in the direction of flow (i.e., in a pipe with a downward slope). See **Section 6.2.2 on page 23**.

When working in a downward-sloping pipe where the water cannot flow forward, the pipe must be pumped out first for efficiency of the recycling impact milling cutter. As the water rises, resistance in the cutter head increases and the impact force decreases. This will be evident by the decreasing vibration of the rinsing hose.

With a steep incline, the hose vibration will be so weak that it almost can't be felt. The operator will no longer be able to determine whether the recycling impact milling cutter is rotating. It can be helpful if a coworker stands near the next manhole and communicates via radio whether milling noise or escaping water are observed. Impact noises confirm good milling operation.



### CAUTION

Only use the recycling impact milling cutter in straight pipes. Failure to comply could lead to considerable damage.



### CAUTION

Use the correct cutter diameter for the pipe to be cleaned. Failure to comply could lead to damage of the pipe wall and tool.



### CAUTION

Never let the recycling impact milling cutter skip, such as by pulling the hose back and suddenly releasing it. Failure to comply could lead to damage of the pipe wall and tool.

**CAUTION**

Do not continue milling if the recycling impact milling cutter pierces a wall. Failure to comply could result in damage to the pipe wall and manhole.



Continue to run the water at low pressure when retracting the tool. This prevents wastewater from entering the tool via the nozzle inserts, which could lead to failure of the tool.



If the impact force is insufficient, pump out the pipe to increase efficiency.



If water can drain but too much water is fed in during milling, regularly stop work to retract the recycling impact milling cutter back 0.5 m and wait until the water has drained.



Use a flex guide, protective sleeve, or roller guide to protect the hose from wear caused by rough surfaces. These devices extend the service life of the hose considerably.

### 5.3 Cleaning pipes with minor damage

Minor damage is usually considered to be cracks in the pipe wall or large pipe offsets. Inform the customer or the appropriate authorities if you notice these issues.

Use extreme caution when working in pipes with minor damage. Use the tool at your own risk. **enz® technik ag** waives all liability.



#### ANGER

Washing out cracks can cause pipe fragments to break off and the material surrounding the pipe to be washed out. Do not use the equipment if you are unsure whether this could occur. The sewer could collapse.



#### CAUTION

The recycling impact milling cutter can get stuck easily in damaged pipes. Do not use the recycling impact milling cutter if cracks or pipe offsets are too large.



Use a worn-out pair of cam plates. This will provide a gentler impact.

### 5.4 After use

Perform the following maintenance after using the recycling impact milling cutter:

- Rinse the recycling impact milling cutter with fresh water.
- Check whether the nozzle inserts are clogged.
- Spray the entire recycling impact milling cutter with OIL SPRAY BIO (C191). Turn the cutter head manually several times.
- Check the carbide teeth for wear. Replace worn carbide teeth.
- Check the torques of all screws per **Section 7.2 on page 33**.



*Figure 2 OIL SPRAY BIO, 500 mL*

## 5.5 Troubleshooting

### 5.5.1 The impact cutter head is not rotating

1. Pull the recycling impact milling cutter back slightly (~20 – 30 cm / 15 inch) to enable the cutter head to rotate again.
2. Shake the high-pressure hose until the impact mechanism releases and the cutter head can rotate freely again.
3. Carefully approach the deposit and continue working.

### 5.5.2 The impact cutter head stops often

The thrust force of the recycling impact milling cutter is too high. Use thrust nozzles with a smaller diameter to reduce the thrust force. See **Section 6.2** on **page 22**.

### 5.5.3 Insufficient impact force

Weak vibration of the rinsing hose indicates insufficient impact force. If this occurs, pull the cutter back and remove it from the manhole. Check the wear of the cam plates and replace them if necessary. See **Section 6.8** on **page 27**.

### 5.5.4 Insufficient impact force despite new cam plates

Grease accumulation behind the center cap is one potential cause of the impact force of the recycling impact milling cutter being too low despite replacing the cam plates. See **Section 6.7** on **page 27**.

### 5.5.5 Recycling impact milling cutter travels upward in the pipe

If the deposit layer is thin but hard, the cutter can ride up onto the deposit and damage the pipe. To prevent this, set the carbide teeth on the outside ring outward. This will keep the cutter moving straight forward.

Once the deposit has been cut into, place the milling teeth back in neutral position. See **Section 8** on **page 37**.

## 6 Maintenance

The maintenance and service activities described in this manual may be performed only by users who have the required knowledge.

Only qualified specialists approved by the manufacturer may perform maintenance and service activities not described in this operating manual.

### 6.1 Intermittent maintenance during milling

Observe the maintenance intervals below when using the cutter.

Task	Interval
Tighten all screws to the correct torque per <b>Section 7.2 on page 33</b> .	Hourly
Check the wear of milling teeth. Replace teeth per <b>Section 6.4 on page 25</b> as necessary.	Hourly
Grease the hub of the recycling impact milling cutter per <b>Section 6.3.1 on page 24</b> .	Without impact hourly With impact every 4 hours
Remove excess grease behind the center cap per <b>Section 6.7 on page 27</b> .	Daily
Grease the swivel joint of the recycling impact milling cutter per <b>Section 6.3.2 on page 24</b> .	Every 20 hours or after every use

*Table 1: Intermittent maintenance during operation*

### 6.2 Checking nozzle inserts

To best coordinate the recycling impact milling cutter to the cleaning truck, enz® needs the following information during order placement:

- Max. pump capacity [l/min] [US gpm]
- Max. pump pressure [bar] [psi]
- Hose diameter [mm] [inch]
- Hose length [m] [feet]
- Hose material Plastic or rubber



If the cleaning truck's parameters change, the calculation of the nozzle inserts of the recycling impact cutter should be checked.

Regularly inspect the nozzle inserts. Wear depends on the degree of contamination of the water used. If recycled water is used, inspect the nozzle inserts **daily** and clean them if necessary.

**CAUTION**

Clogged nozzle inserts impair cleaning results and increase risk when working with high pressure. Inspect the nozzle inserts daily if recycled water is used.

### 6.2.1 Replacing the nozzle inserts

Use the nozzle calculation program at [my.enz.com](http://my.enz.com) to determine the diameter of the nozzle inserts if you do not know it.

1. Remove the old nozzle inserts.
2. Clean the threaded holes as well as the threads on the new nozzle inserts. All threads must be free of lubricant.
3. Coat the threads of the nozzle inserts with Loctite 243 (Art. No. C192).
4. Immediately screw the nozzle inserts into the tool body as far as they will go. Use a socket wrench to tighten the inserts.
5. The compound must cure for at least 24 hours.

**CAUTION**

Only replace damaged nozzle inserts with identical nozzle inserts of the same diameter. If the tool is not correctly outfitted, the tool or the pipe may be damaged.

### 6.2.2 Adjusting the thrust for different pipe inclinations

The recycling impact milling cutter ships in its default setup. This setup is suitable for most use cases in pipes with a slight incline, working against the direction of flow. The nozzle inserts on the swivel joint determine the thrust force. If the force is too low, the recycling impact milling cutter will not glide into the pipe as desired. If the force is too high, the cutter will drive into the deposit with excessive force, bringing the cutter head to a standstill.

The operator must fine tune the thrust during milling. The recycling impact milling cutter has been set up properly when it doesn't pull on the hose strongly. We recommend always having various sizes of nozzle inserts on the job site.

**CAUTION**

Only change the thrust. Do not change the nozzle inserts for the cutter head's rotation. Failure to comply can lead to cutter or pipe damage.

Install larger nozzle inserts on the swivel joint if working in a pipe with a steep incline.

The recycling impact milling cutter requires less thrust to glide into the pipe if milling from top to bottom. In this case, replace the nozzle inserts on the thrust nozzle with smaller ones.

### 6.3 Greasing rotating parts

#### 6.3.1 Cutter hub

Grease the cutter hub before use, every four hours during milling, and after use. Use the high-performance grease because of the high mechanical demand on the system (Art. No. 14.99008).

Use the supplied grease gun (Art. No. 14.99004) to grease the cutter hub. Place the hose on the grease nipple of the cutter head and pump in grease until the grease gun lever presents a high resistance.

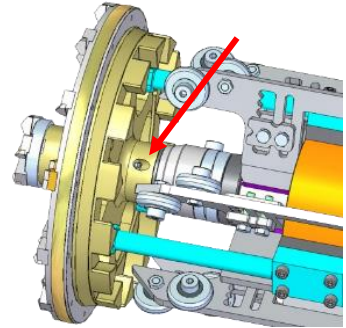


Figure 3: Grease nipple location



#### CAUTION

Always use the supplied high-performance grease (Art. No. 14.99008). Other greases can destroy the recycling impact milling cutter.

#### 6.3.2 Swivel joint

Grease the swivel joint between the recycling impact milling cutter and the rinsing hose every 20 hours or after every use. Use the grease gun (Art. No. 14.99004) the high-performance grease (Art. No. 14.99008). Use the supplied adapter for the grease gun (Art. No. 14.99009).



Figure 4: Adapter 14.99009

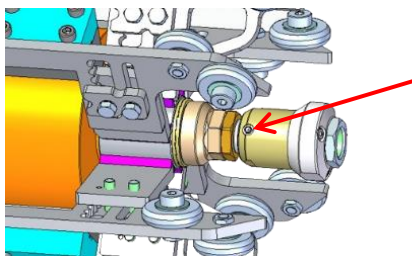


Figure 5: Grease nipple on swivel joint

## 6.4 Replacing milling teeth

1. Remove the hex head screw and Nord-Lock washer.
2. Remove the old milling tooth and clean the contact surface.
3. Grease the thread of the screw with the high-performance grease (Art. No. 14.99008). Set the Nord-Lock washer in place. Install the new milling tooth in the desired position per **Section 8** on **page 37**.
4. Tighten the screws of all milling teeth to 38 Nm.

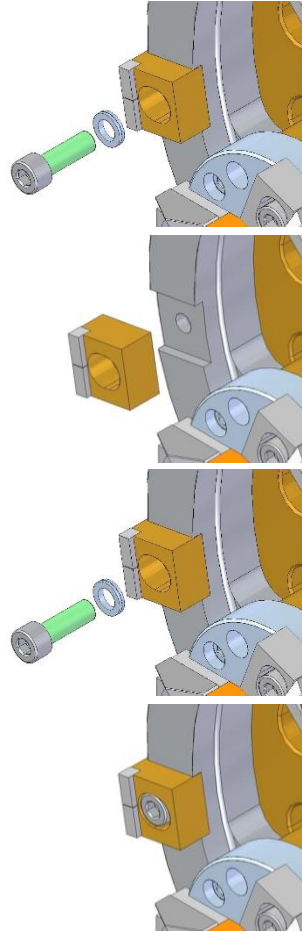


Figure 6: Replacing a milling tooth

## 6.5 Removing the center cap

1. Remove the seven hex head screws.
  - ❗ The screws are secured with Tuflok and can be loosened with a hex key.

2. Remove the center cap by tapping it forward with a nylon hammer evenly around its circumference.

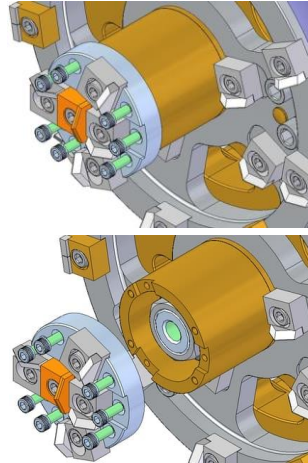


Figure 7: Removing the center cap

## 6.6 Installing the center cap

1. Clean the contact surfaces and the screws. Remove oil and grease from the inner and outer thread. Place the center cap on the hub. Coat the screws with Loctite 243 (Art. No. C192).
2. Tighten the screws to 10 Nm using a torque wrench. The compound must cure for at least 24 hours.

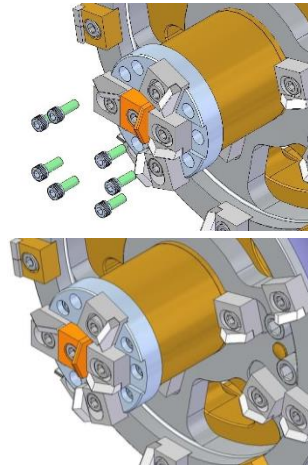
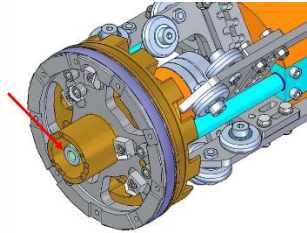


Figure 8: Installing the center cap

## 6.7 Removing excess grease from the cutter hub

1. Remove the center cap.  
See **Section 6.5** on **page 26**.
2. Remove excess grease from the cutter hub. Perform this process daily.
3. Install the center cap.  
See **Section 6.6** on **page 26**.



*Figure 9: Removing excess grease from the cutter hub*

## 6.8 Replacing the cam plates

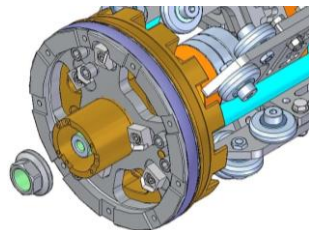
The cam plates (Art. No. 14.KR35) are wear parts that must be replaced regularly. The degree of wear depends on the demand placed on the recycling impact milling cutter. Cam plates are normally replaced every 50 hours or when the stroke is shorter than 2 mm.

To check the wear, press the cutter head against the cam plates and slowly rotate the cutter head by hand. This causes the cam plates to move the cutter head back and forth. This stroke must be at least 2 mm. If the stroke is shorter, both cam plates are worn and must be replaced. Perform the following to replace the cam plate:

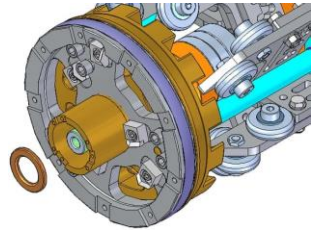
1. Remove the center cap.  
See **Section 6.5** on **page 26**.
2. Remove the lock nut.



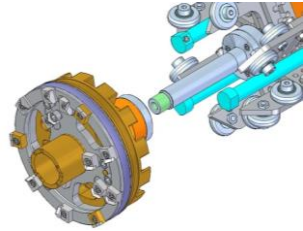
*Figure 10  
Cam plate  
14.KR35W*



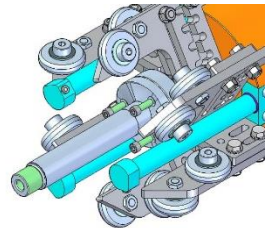
3. Remove the aluminum bronze washer from the shaft.



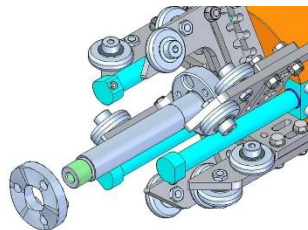
4. Pull the hub off the shaft.



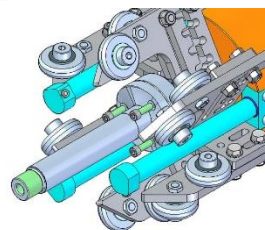
5. Remove the three screws on the cam plate.



6. Replace the cam plates with a new one (Art. No. 14.KR35W).

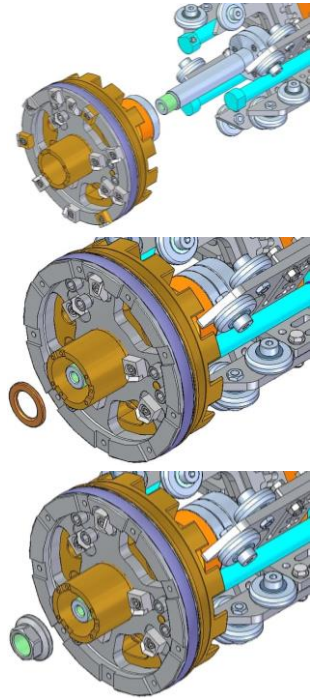


7. Tighten the screws to 38 Nm.



8. Repeat steps 5 – 7 on the rear of the hub.

9. Place the hub on the shaft.
10. Grease the aluminum bronze washer with the high-performance grease (Art. No. 14.99008) and place it on the shaft. Use a new washer if necessary. See **Section 6.9** on **page 30**.
11. Grease the lock nut with the high-performance grease (Art. No. 14.99008) and tighten it to 200 Nm.
12. Install the center cap.  
See **Section 6.6** on **page 26**.



*Figure 11: Replacing the cam plates*

## 6.9 Replacing the aluminum bronze washer

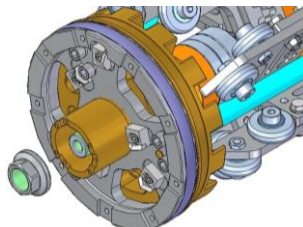
The aluminum bronze washer (Art. No. 0014.NAR08) protects the rigid parts by accepting the torque on the cutter head. If this washer is not greased sufficiently, wear will increase, and the washer will need to be replaced. Replace the aluminum bronze washer when it is thinner than 2 mm.



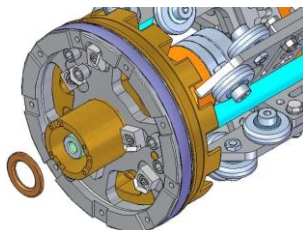
*Figure 12 Aluminum bronze washer 0014.NAR08*

1. Remove the center cap.  
See **Section 6.5** on **page 26**.

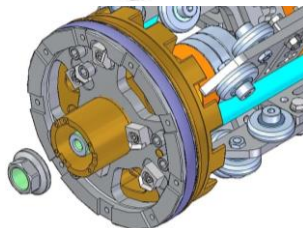
2. Remove the lock nut.



3. Replace the aluminum bronze washer on the shaft with a new one and grease it with the high-performance grease (Art. No. 14.99008).



4. Grease the lock nut with the high-performance grease (Art. No. 14.99008) and tighten it to 200 Nm with a torque wrench.



5. Install the center cap.  
See **Section 6.6** on **page 26**.

*Figure 13: Replacing the aluminum bronze washer*

## 6.10 Disposal and environmental protection

The tools do not require any special disposal procedure, and they can be disposed of with other scrap metal.

Only clean pipes for which the composition of the wastewater is known (industrial wastewater in particular). Chemicals and other toxic substances shall never be allowed to enter the environment via defective pipes.

Report defective pipes or leaking substances to the supervisory body or appropriate authorities.

Do not use excessive water. This will help conserve our natural resources.

## 7 Technical specifications

### 7.1 Nomenclature

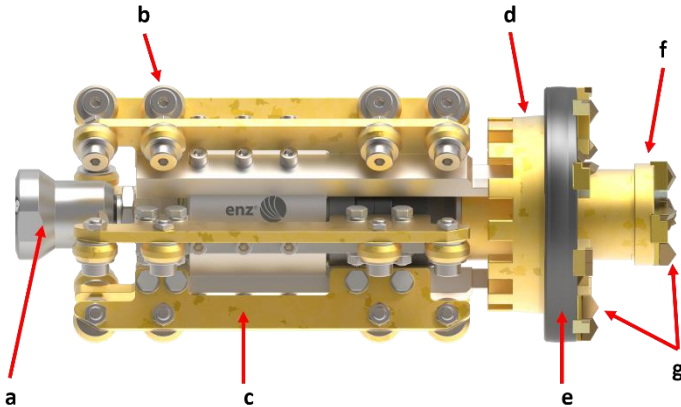











Figure 14: Nomenclature of 14.250R

#### Key

- |                    |                |                  |
|--------------------|----------------|------------------|
| a: Swivel joint    | d: Hub         | g: Milling teeth |
| b: Roller for Skid | e: Cutter head |                  |
| c: Skid            | f: Center cap  |                  |

Article number		14.200RP	14.200R	14.225R	14.250R
	Connection thread	1" 1 1/4"			
	Rotating nozzles	3xM10			
	Thrust nozzles	3xM10			
	Can use recycled water	YES			
	Weight	43 kg	43.4 kg	46.0 kg	52.3 kg
	Application range in mm (inch)	190 (7.5)	200 (7.9)	225 (8.9)	250 (9.8)
	Dimensions in mm (inch)	180x587 (7.1x23.1)	187x587 (7.4x23.1)	205x587 (8.1x23.1)	225x587 (8.9x23.1)
	Min. flow rate at 100 bar (1450 psi)	200 L/min 53 US gpm			
	Maximum working pressure	150 bar 2200 psi			

## 7.2 Screw torques

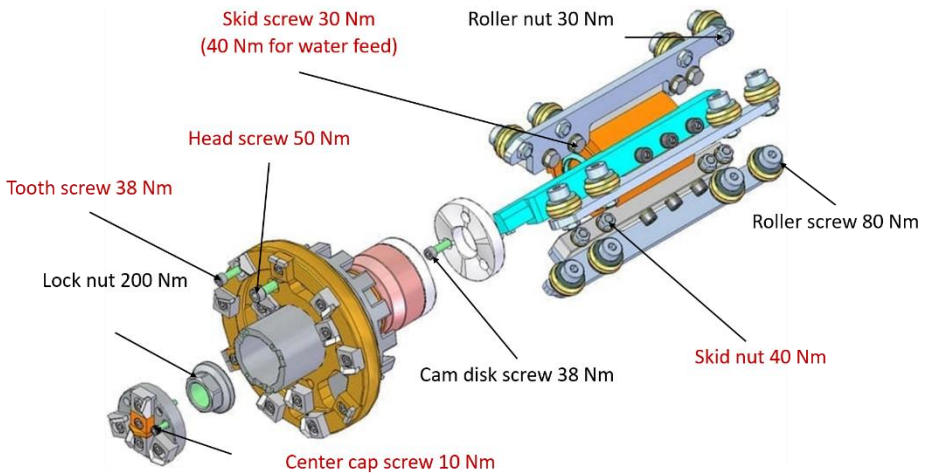


Figure 15: 14.2xxR torques



### CAUTION

Check all torques in **red** with a torque wrench at the start of work, after two minutes, and then hourly. Nonobservance can lead to ejected parts or damage to the cutter.

### 7.3 Retrofitting the recycling impact milling cutter to other diameters

200-series recycling impact milling cutters can be retrofitted to four different diameters. To retrofit the cutter, the skids and cutter head must be converted. enz® offers complete retrofit kits for this.



**Please note!**

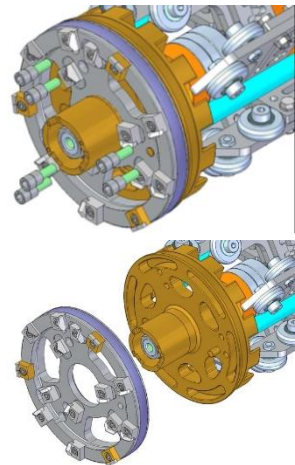
The same milling head is used for the 190 mm (7.5 inch) and 200 mm (7.8 inch) diameters.

Diameter	Name	Article number
190 mm / 7.5 inch	Retrofit kit from 14.225R / 14.250R to 14.200RP	14.200KRP-KIT
200 mm / 7.8 inch	Retrofit kit from 14.2xxR to 14.200R	14.200KR-KIT
225 mm / 8.9 inch	Retrofit kit from 14.2xxR to 14.225R	14.225KR-KIT
250 mm / 9.9 inch	Retrofit kit from 14.2xxR to 14.250R	14.250KR-KIT

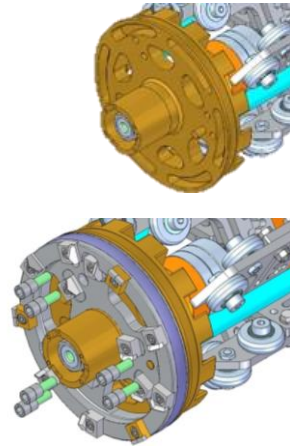
Table 2: Retrofit kit overview

#### 7.3.1 Replacing the cutter head

1. Remove the center cap.  
See **Section 6.5** on **page 26**.
2. Remove the six hex head screws for the cutter head.  
  - ❗ The screws are secured with Loctite but can be loosened with a hex key.
3. Remove the cutter head from the hub.



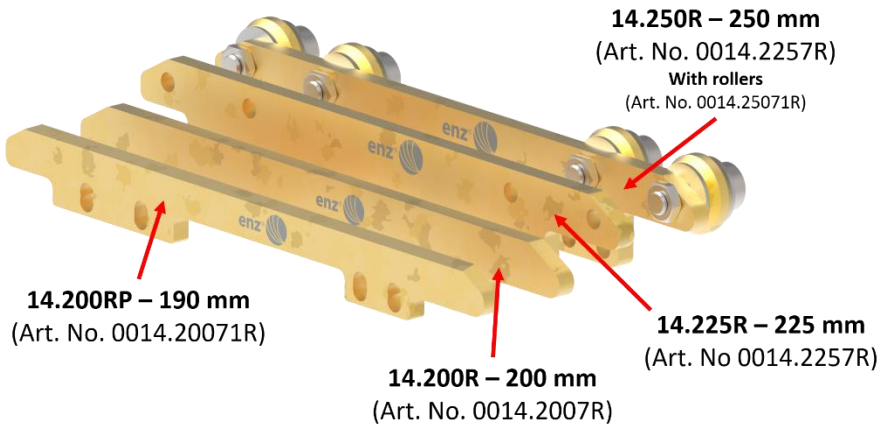
4. Clean the contact surfaces. Remove oil and grease from the internal threads and the screws. Install the new cutter head. The centering pin guides it to the correct position.
5. Place the bushings on the hex head screws. Coat the threads of the six screws with Loctite 243 (Art. No. C192). Tighten the screws to 50 Nm using a torque wrench.
6. Install the center cap.  
See **Section 6.6** on **page 26**.



*Figure 16: Replacing the cutter head*

### 7.3.2 Adjusting the skids

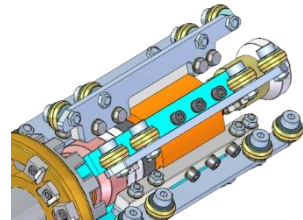
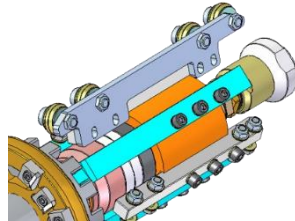
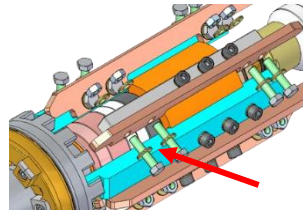
The same skids can be used when converting the skid diameter from 225 mm to 250 mm. The rollers (Art. No. 0014.25071R) must be installed individually.



*Figure 17: Skids overview*

Follow the instructions below to convert the skids.

1. Remove the screws and the skids.
  
2. Install the new skids. Ensure that the screw length is correct. Screws of different lengths are required based on the installation location. See **Drawing 2** on **page 48**.
  
3. Tighten all screws to the correct torque per **Section 7.2** on **page 33**.



*Figure 18: Skids overview*

## 8 Milling tooth

### 8.1 Milling tooth overview

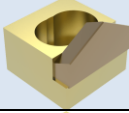
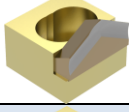
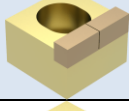
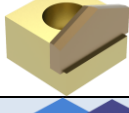

Figure	Article number	Application
	15.ZU	Limescale
	15.ZU-GSL	Plastic
	15.ZHU	Limescale
	15.Z1	Limescale Concrete
	15.ZD	Concrete

Table 3: Milling tooth overview

### 8.2 Tooth position overview

Pipe material	Deposit			Tooth position
	Lime	Concrete	Plastic	
Concrete- and Cast-Iron pipe	With	With	Without	Neutral
				Inside
Plastic pipe				Neutral
	Without	Without	Without	Inside
15.ZU			Percussion:	With
15.ZU-GSL				Without
15.ZD				

Table 4: Tooth position overview

### 8.3 Milling teeth on the center cap

Ensure that the three outer universal milling teeth (Art. No. 15.ZU) of the center cap are always installed outward and that the inner universal milling tooth is always in the neutral position. The milling tooth for the center (Art. No. 15.Z1) must be installed exactly centered.

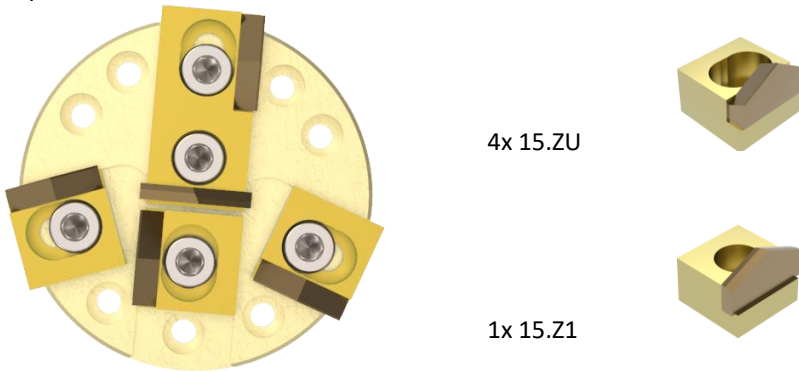


Figure 19: Milling teeth on the center cap

### 8.4 Milling teeth on the inside ring

Install all milling teeth on the inside ring of the cutting head in a neutral position. The universal milling tooth (Art. No. 15.ZU) is installed as standard.

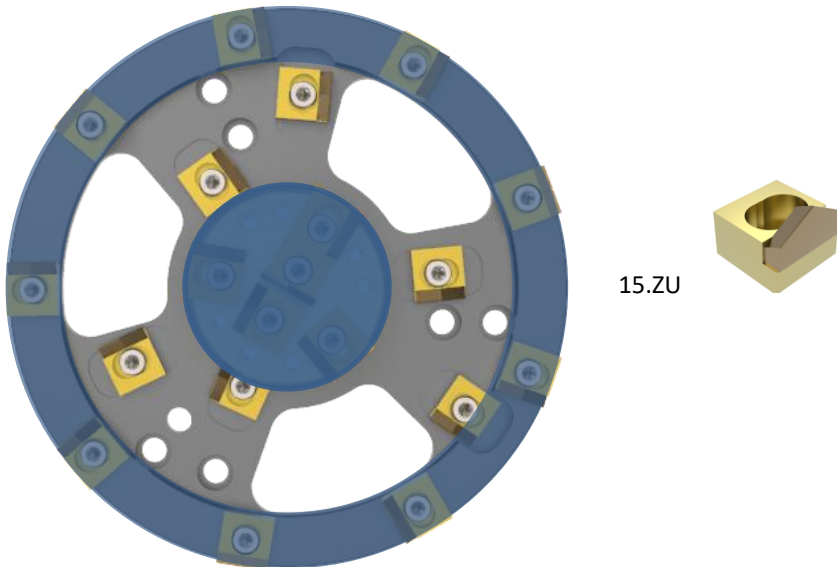


Figure 20: Milling teeth on the inside ring

## 8.5 Milling teeth on the outside ring

Two or three circumferential milling teeth (Art. No. 15.ZHU) are installed on the outside ring as standard to protect the remaining universal milling teeth (Art. No. 15.ZU) from significant wear.

The universal milling teeth (Art. No. 15.ZU) on the outside ring are installed in the neutral position as standard.

When milling plastic pipes, install all milling teeth on the outside ring inward. The universal milling teeth can be installed outward for a deposit that inclines slightly (Art. No. 15.ZU). See **Section 5.5.5 on page 21**.

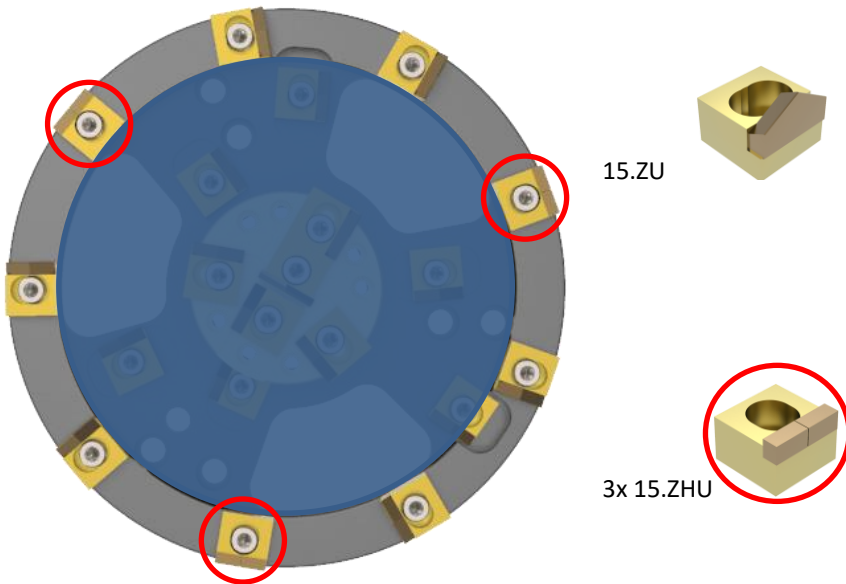





Figure 21: *Milling teeth on the outside ring*

8.5.1 **Tooth positions on the outside ring**

	<p>In the standard setup, the universal milling tooth 15.ZU is installed in the neutral position for concrete or steel pipes.</p>
	<p>In cast iron, steel, and concrete pipes, the universal milling tooth can be installed outward.</p>
	<p>In plastic pipes, the universal milling tooth 15.ZU is installed inward to prevent pipe wall damage.</p>

*Table 5: Tooth positions on the outside ring*



Always install the milling tooth for plastic (15.ZU-GSL) in the neutral position.

8.6 **Milling in plastic pipes**

8.6.1 **PE pipes**

Install the milling teeth on the outside ring inward to avoid damaging plastic pipes. Remove the screws for the outer milling teeth. Remove the teeth and install them inward. Tighten the teeth to 38 Nm with a torque wrench.

8.6.2 **PVC pipes**

PVC pipes may only be milled if they are embedded in concrete. The process is the same as for milling PE pipes. Install the milling teeth on the outside ring inward to prevent damage to the pipe.

## 8.7 Setup for limescale deposits

Set up the cutter head with the universal milling teeth (Art. No. 15.ZU) in the neutral position and two or three circumferential milling teeth (Art. No. 15.ZHU) on the outside ring.

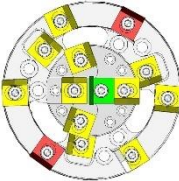
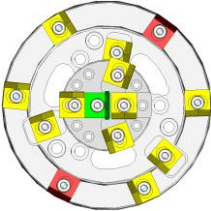
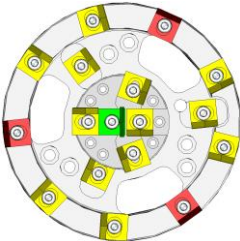
Figure	15.ZU	15.ZHU	15.Z1
<b>14.200R</b> 	11	2	1
<b>14.225R</b> 	11	2	1
<b>14.250R</b> 	13	3	1

Table 6: 14.2xxR setup for limescale deposits

## 8.8 Limescale deposits in plastic pipes

To mill limescale deposits in plastic pipes, install the universal milling teeth (Art. No. 15.ZU) on the outside ring inward and replace the circumferential milling teeth (Art. No. 15.ZHU) with universal milling teeth.

### 8.9 Wood and plastic deposits

Use milling teeth for plastic (Art. No. 15.ZU-GSL) to mill wood and plastic deposits in a pipe. Install these teeth in the neutral position on the outside and inside rings. Replace the circumferential milling teeth (Art. No. 15.ZHU) with 15.ZU-GSL teeth. Install universal milling teeth (Art. No. 15.ZU) on the center cap.

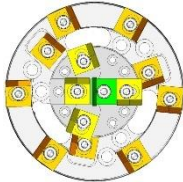
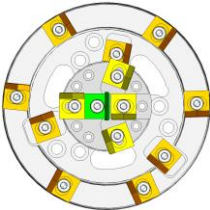
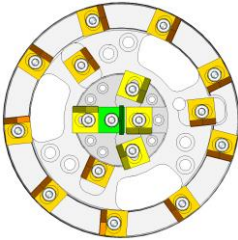
Figure	15.ZU	15.ZU-GSL	15.Z1
<p>14.200R</p> 	4	9	1
<p>14.225R</p> 	4	9	1
<p>14.250R</p> 	4	12	1

Table 7: 14.2xxR setup for wood and plastic deposits



If the pipe is more than half filled with plastic deposits, the milling teeth for plastic (Art. No. 15.ZU-GSL) can also be installed on the center cap.

### 8.10 Setup for concrete deposits

Diamond milling teeth (Art. No. 15.ZD) are suitable for very hard deposits, such as concrete, which the impact milling cutter does not have enough power for with the universal milling teeth (Art. No. 15.ZU). The diamond milling teeth are installed along the entire outside ring.

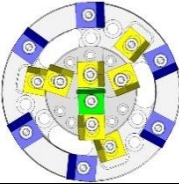
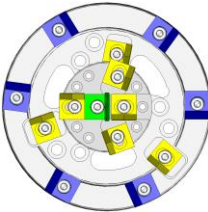
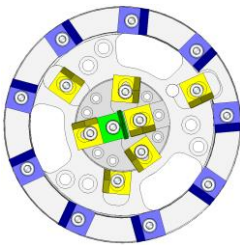
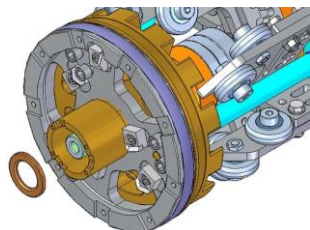
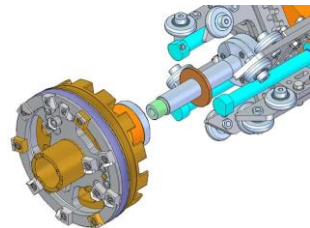
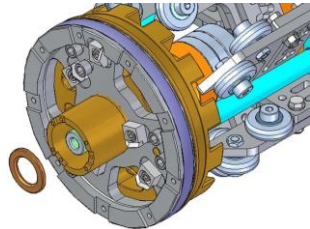
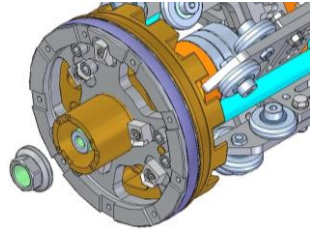
Figure	15.ZU	15.ZD	15.Z1
<p>14.200R</p> 	7	6	1
<p>14.225R</p> 	7	6	1
<p>14.250R</p> 	7	9	1

Table 8: 14.2xxR setup for concrete deposits

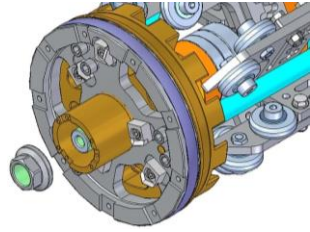
## 9 Special applications

### 9.1 Turning impact on and off

1. Remove the center cap.  
See **Section 6.5** on **page 26**.
2. Remove the lock nut.
3. Remove the aluminum bronze washer from the cutter shaft.
4. Remove the cutter hub from the shaft and place the spacer (Art. No. 14.D80) on the shaft. Grease the shaft with the high-performance grease (Art. No. 14.99008) and place the hub on the shaft.
5. Grease the aluminum bronze washer with the high-performance grease (Art. No. 14.99008) and place it on the shaft.



6. Grease the lock nut with the high-performance grease (Art. No. 14.99008) and tighten it to 200 Nm with a torque wrench.
7. Install the center cap.  
See **Section 6.6** on **page 26**.



*Figure 22: Turning impact on and off*



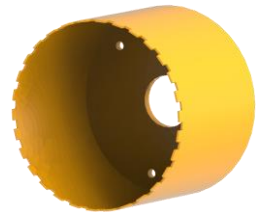
To turn impact back on, follow steps 1 – 7, but remove the spacer.

## 9.2 Milling with the diamond crown drill bit

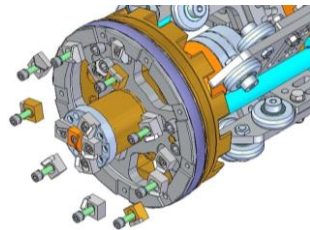
The diamond crown drill bit removes pipe inlets, steel anchor bolts, and pipelines in pipes and sewers. We offer the diamond crown drill bit for a pipe diameter of 200 mm to 250 mm.

Perform the following to install or remove the diamond crown drill bit:

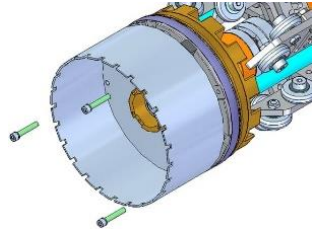
1. Remove all milling teeth on the outside ring.
2. Ensure that the cutter is set up for work without impact. See **Section 9.1** on **page 44**.



*Figure 23:  
Diamond crown drill bit*



3. Place the diamond crown drill bit on the cutter head. Coat the three screws with high-performance grease (Art. No. 14.99008). Place Nord-Lock washers on the screws. Tighten the screws to 38 Nm using a torque wrench.
  
4. Install the center cap.  
See **Section 6.6** on **page 26**.

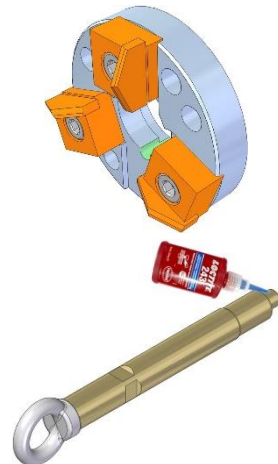


Perform the procedure in the reverse sequence to revert the assembly. See **Section 7.2** on **page 33** for torque specifications.

*Figure 24: Installing the diamond crown drill bit*

### 9.3 Installing the pull rod

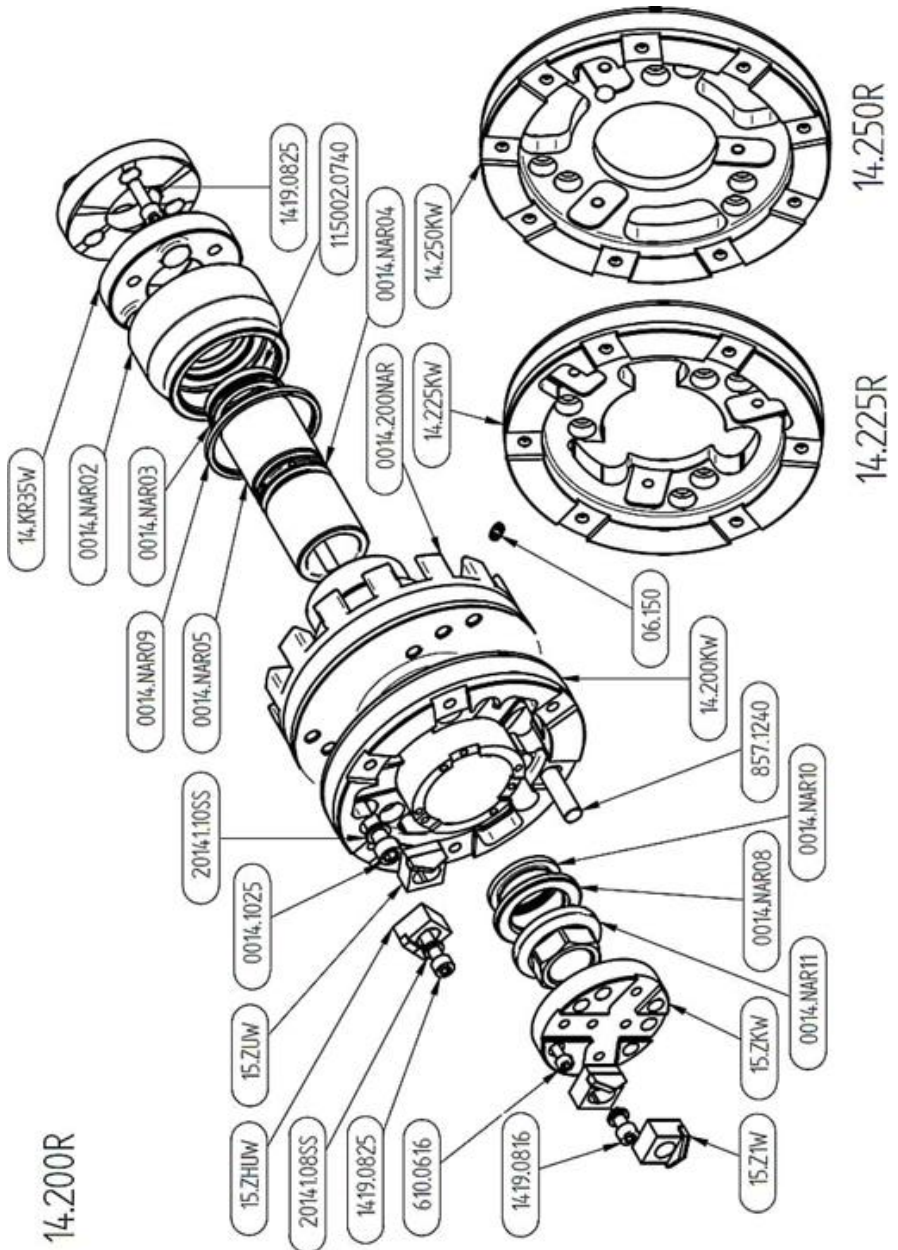
1. Remove the center cap.  
See **Section 6.5** on **page 26**.
  
2. Replace the center cap with the center cap with borehole (Art. No. 15.ZKB). Coat the screws with Loctite 243 (Art. No. C192) and tighten them to 10 Nm.
  
3. Coat the pull rod with Loctite 243 (Art. No. C192) and tighten it onto the cutter shaft at 100 Nm. The compound must cure for at least 24 hours.



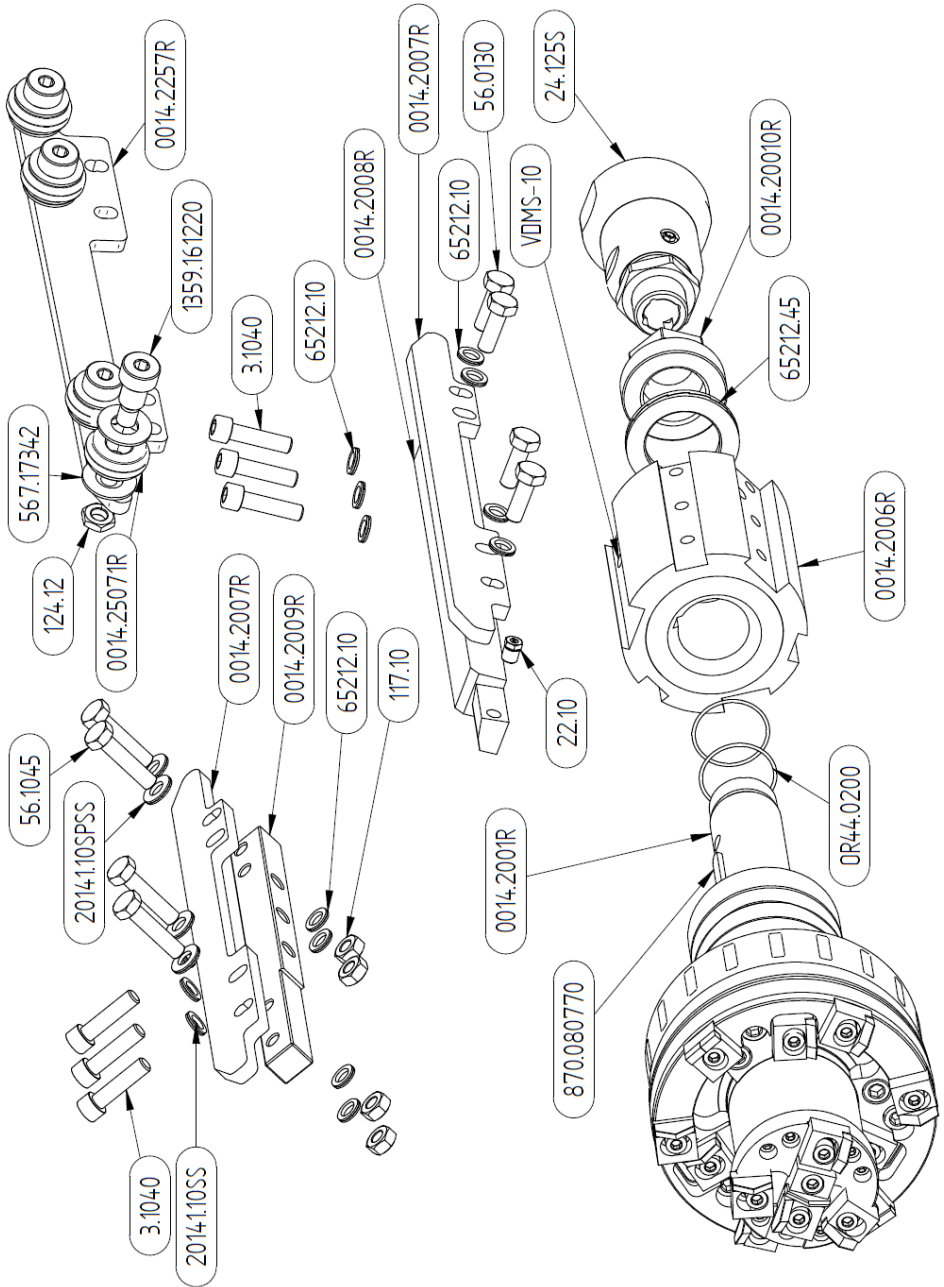
Perform the procedure in the reverse sequence to revert the assembly. See **Section 7.2** on **page 33** for torque specifications.

*Figure 25: Installing the pull rod*

# 10 Spare parts/accessories



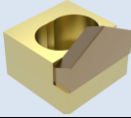
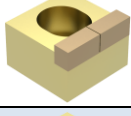
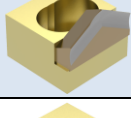
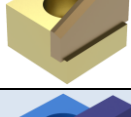

Drawing 1 Exploded drawing of head 14.2004R



Drawing 2 Exploded drawing of 14.2xxR cage

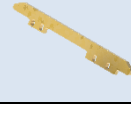
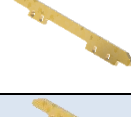

# 11 Accessories

## 11.1 Milling teeth

Figure	Article number	Name	Application
	15.ZU	Universal milling tooth	14.200R – 14.250R
	15.ZHU	Circumferential milling tooth	14.200R – 14.250R
	15.ZU-GSL	Milling tooth for plastic	14.200R – 14.250R
	15.Z1	Milling tooth for center	14.200R – 14.250R
	15.ZD	Diamond milling tooth	14.200R – 14.250R

*Table 9: Milling tooth accessories*

## 11.2 Retrofit kit

Figure	Article number	Name	Application
	14.200RP-KIT	Retrofit kit from 14.200R to 14.200RP	14.200RP
	14.200R-KIT	Retrofit kit from 14.200RP to 14.200P	14.200R
	14.200KRP-KIT	Retrofit kit from 14.225R / 14.250R to 14.200RP	14.200RP




	14.200KR-KIT	Retrofit kit from 14.2xxR to 14.200R	14.200R
	14.225KR-KIT	Retrofit kit from 14.2xxR to 14.225R	14.225R
	14.250KR-KIT	Retrofit kit from 14.2xxR to 14.250R	14.250R

Table 10: Retrofit kits

### 11.3 Center caps and cutter heads






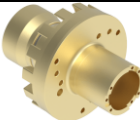
Figure	Article number	Name	Application
	15.ZK	Center cap	14.200R – 14.250R
	15.ZKB	Center cap with borehole for pull rod	14.200R – 14.250R
	14.200KR	Impact cutter head with teeth, 200 mm	14.200R
	14.225KR	Impact cutter head with teeth, 225 mm	14.225R
	14.250KR	Impact cutter head with teeth, 250 mm	14.250R
	14.200NAR	Hub for recycling impact milling cutter	14.200R – 14.250R

Table 11: Accessories for center caps and cutter heads

## 11.4 Diamond crown drill bit

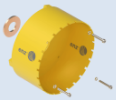
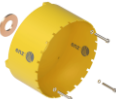
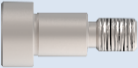



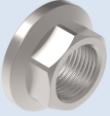





Figure	Article number	Name	Application
	14.200D	Diamond crown drill bit	14.200R
	14.250D	Diamond crown drill bit	14.250R

Table 12: Accessories for diamond crown drill bit

## 11.5 Miscellaneous

Figure	Article number	Name	Application
	14.KR35W	Cam plate 3.5 mm	14.200R – 14.250R
	1419.0825	Cylinder-head screw for Cam plate	14.K35W
	0014.20071R	Skid $\varnothing$ 180	14.180R
	0014.2007R	Skid $\varnothing$ 200	14.200R
	0014.2257R	Skid $\varnothing$ 225 – 250	14.225R – 14.250R
	0014.25071R	Skid roller $\varnothing$ 40 mm	14.250R
	1359.161220	Shoulder bolt for skid roller s	14.250R

	567.17342	Washer for skid rollers	14.250R
	124.12	Hex nut for skid rollers	14.250R
	14.D80	Spacer	14.200R – 14.250R
	0014.NAR11	Lock nut	14.200R – 14.250R
	0014.NAR08	Aluminum bronze washer	14.200R – 14.250R
	14.ZSR	Pull rod	14.200R – 14.250R
	20141.08SS	M8 Nord-Lock wedge lock washer	14.200R – 14.250R
	20141.10SPSS	M10 Nord-Lock wedge lock washer	14.200R-14.250R
	24.125S	Swivel joint with thrust nozzles	14.200R – 14.250R
	14.99001	Torque wrench	
	14.99002	3/4" hex socket	

	14.99003	Transition piece with magnet, 3/4" to 1/2"	
	14.99004	Manual grease gun	
	14.99009	Grease gun adapter	
	14.99008	High-performance grease	
	C191	OIL SPRAY BIO 500 mL	
	C192	Loctite 243 50 mL	

Table 13: Miscellaneous accessories

## 12 Index

### 12.1 Figures

Figure 1: <b>Basic function</b> .....	12
Figure 2 <b>OIL SPRAY BIO, 500 mL</b> .....	20
Figure 3: <b>Grease nipple location</b> .....	24
Figure 4: <b>Adapter 14.99009</b> .....	24
Figure 5: <b>Grease nipple on swivel joint</b> .....	24
Figure 6: <b>Replacing a milling tooth</b> .....	25
Figure 7: <b>Removing the center cap</b> .....	26
Figure 8: <b>Installing the center cap</b> .....	26
Figure 9: <b>Removing excess grease from the cutter hub</b> .....	27
Figure 10 <b>Cam plate 14.KR35W</b> .....	27
Figure 11: <b>Replacing the cam plates</b> .....	29
Figure 12 <b>Aluminum bronze washer 0014.NAR08</b> .....	30
Figure 13: <b>Replacing the aluminum bronze washer</b> .....	30
Figure 14: <b>Nomenclature of 14.250R</b> .....	32

Figure 15: **14.2xxR torques** ..... 33  
 Figure 16: **Replacing the cutter head** ..... 35  
 Figure 17: **Skids overview** ..... 35  
 Figure 18: **Skids overview** ..... 36  
 Figure 19: **Milling teeth on the center cap** ..... 38  
 Figure 20: **Milling teeth on the inside ring** ..... 38  
 Figure 21: **Milling teeth on the outside ring** ..... 39  
 Figure 22: **Turning impact on and off** ..... 45  
 Figure 23: **Diamond crown drill bit** ..... 45  
 Figure 24: **Installing the diamond crown drill bit** ..... 46  
 Figure 25: **Installing the pull rod** ..... 46

## 12.2 Drawings

Drawing 1 **Exploded drawing of head 14.2004R** ..... 47  
 Drawing 2 **Exploded drawing of 14.2xxR cage** ..... 48

## 12.3 Tables

Table 1: **Intermittent maintenance during operation** ..... 22  
 Table 2: **Retrofit kit overview** ..... 34  
 Table 3: **Milling tooth overview** ..... 37  
 Table 4: **Tooth position overview** ..... 37  
 Table 5: **Tooth positions on the outside ring** ..... 40  
 Table 6: **14.2xxR setup for limescale deposits** ..... 41  
 Table 7: **14.2xxR setup for wood and plastic deposits** ..... 42  
 Table 8: **14.2xxR setup for concrete deposits** ..... 43  
 Table 9: **Milling tooth accessories** ..... 49  
 Table 10: **Retrofit kits** ..... 50  
 Table 11: **Accessories for center caps and cutter heads** ..... 50  
 Table 12: **Accessories for diamond crown drill bit** ..... 51  
 Table 13: **Miscellaneous accessories** ..... 53

A dynamic splash of clear blue water with numerous bubbles, moving from the right side of the frame towards the left, creating a sense of motion and freshness.

enz® technik ag  
Schwerzbachstrasse 10  
6074 Giswil, Switzerland  
Phone +41 41 676 77 66  
info@enz.com  
www.enz.com